



# TTC80F

3-phase controller for electric heating,  
400 V / 80 A

TTC80F is a 3-phase controller intended for time-proportional control of electric heaters, radiators, etc. The controller is capable of controlling both D- and Y-connected loads.

- 3-phase 400 V AC +/- 10%, max. 55 kW
- PI-control for supply air control and P-control for room control
- Can be controlled with external 0...10V control signal

- For DIN-rail mounting
- Settable min. and max. limitation
- Adjustable cycle time

TTC80F is a 3-phase triac controller for control of electric heaters. The device is connected in series between the power supply and an electric heater or radiator.

TTC80F has a temperature controller with inputs for sensors placed, for instance, in a supply air duct or room. It can also be controlled using an external control signal. The controller utilises stepless, time-proportional control. I.e.: the ratio between on-time and off-time is varied in order to fit the present heating requirement.

Example: A controller output of 50 % will equal an on-time of 30 s and an off-time of 30 s if the cycle time is 60 s. The cycle time is adjustable 6...120 s.

Triac control is considerably more accurate than on/off control, meaning increased heating comfort and lowered energy costs.

TTC80F has a built-in function for automatically adapting the control mode as needed:

#### Supply air control

For rapid temperature changes, the supply air controller will function as a PI-controller. The P-band will be 20K with an I-time of 6 minutes.

#### Room temperature control

For slower temperature changes, the room controller will function as a P-controller. The P-band will be 1.5K. The supply air controller will retain the same settings as before. During room temperature control, the supply air temperature can be provided with a min. or max. limitation.

#### Control of larger loads

In cases where the electric heater is larger than the capacity of TTC80F, the load can be divided and controlled by use of a TT-S4/D or TT-S6/D step controller in combination with the TTC80F. Slave control of one or more TTC25X / TTC40FX units via the TTC80F is also possible.

#### External control signal

TTC80F can also be run against a 0...10 V DC control signal from another controller. 0 V input signal will give 0 % output and 10 V input will give 100 % output.

Minimum and maximum limit functions are not active when using an external control signal.

## Technical data

Supply voltage	3-phase, 400V AC. Automatic adaptation
Power output	Max. 80 A, min. 4 A/phase. At 400 V, max. effect will be 55 kW
Safety function	The feed to the TTC should be interlocked with a high temp. limit switch
Power emission	150 W at full load
Cycle time	Factory setting 60 sec. Adjustable 6...120 sec
Indicator	Red LED, lit when power is pulsed to heater
Ambient temperature, operation	0...40°C
Ambient humidity	Max 90 %rH
Storage temperature	-40...+50°C
Protection class	IP20



**Low Voltage Directive (LVD) standards:** This product conforms to the requirements of the European Low Voltage Directive (LVD) 2006/95/EC through product standard EN 60730-1.

**EMC emissions & immunity standards:** This product conforms to the requirements of the EMC Directive 2004/108/EC through product standards EN 61000-6-1 and EN 61000-6-3.

**RoHS:** This product conforms with the Directive 2011/65/EU of the European Parliament and of the Council.

## Control unit

Sensor inputs	Main and min./max. sensor. Min./max. sensor: working range 0...60°C
Main setpoint	0...30°C. Other areas dependant on connected sensor. Includes external setpoint (e.g. TG-R430)
Control parameters, primary control	Rapid control circuits: PI-function with a P-band of 20K and I-time of 6 minutes. Slower control circuits: P-function with a P-band of 1.5 K
Setpoint, min. limitation	0...30°C
Setpoint, max. limitation	20...60°C
Control parameters, limitation	PI-function with a P-band of 20K and an I-time of 6 minutes
Output signal, controller	0...10 V. Connected to control input of output unit by wire strap (terminal 7-9)

## Dimensions

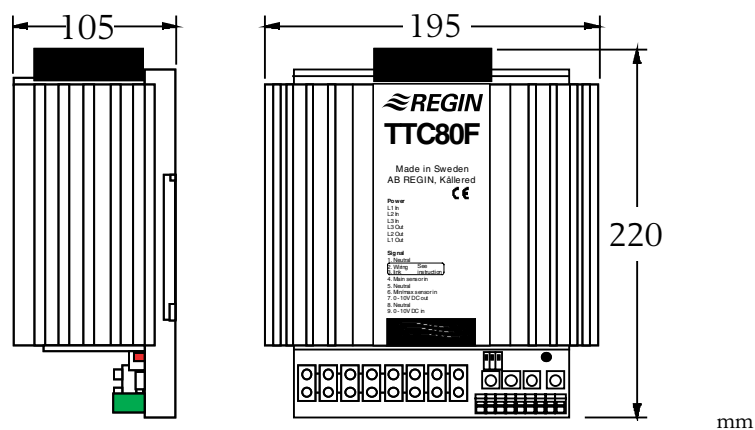

## Wiring

### Power

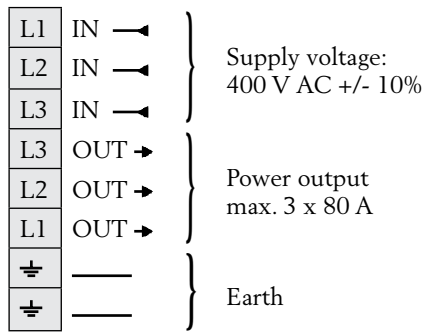

### Room temperature control

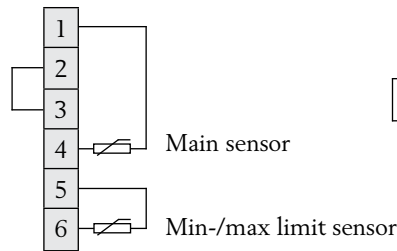

### Room temperature control with external setpoint

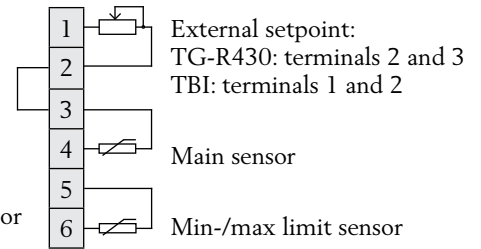

NOTE: When controlling Y-connected loads, the load must be symmetric and the signal neutral must not be connected!

### Constant supply air

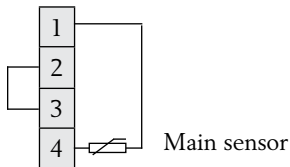

### External signal 0...10 V DC

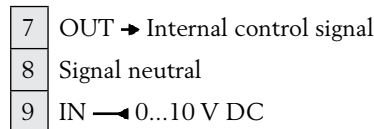

Terminals 7 and 9 are connected by a factory-mounted wire strap. Remove the wire strap when using external control signal.

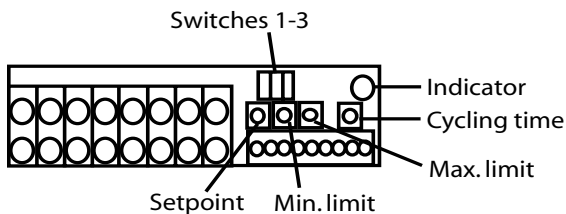

### Operating switches:

- 1 - Setpoint:  
Up: Built-in setpoint  
Down: External setpoint
- 2 - Min. temp. limit.:  
Up: Activated  
Down: Deactivated
- 3 - Max. temp. limit.:  
Up: Activated  
Down: Deactivated
- Min. and max. limit.  
function can be active  
simultaneously

## Product documentation

Document	Type
Instruction TTC80F	Instruction for TTC80F

The documents can be downloaded from [www.regin.se](http://www.regin.se).